



INSTRUCTIONS D'ASSEMBLAGE
ASSEMBLY INSTRUCTIONS

MONARCH
SPECIALTIES INC.

I 3286

TABLE DE SALON -
BLANC LUSTRE AVEC VERRE TREMPE

COFFEE TABLE -
GLOSSY WHITE WITH TEMPERED GLASS





**POUR DE L'ASSISTANCE OU POUR COMMANDER
DES PIÈCES CONTACTEZ NOTRE DÉPARTEMENT
DE SERVICE À LA CLIENTÈLE.**

**FOR ASSISTANCE OR TO ORDER PARTS
CONTACT OUR CUSTOMER SERVICE DEPARTMENT**

WWW.MONARCHSERVICE.COM

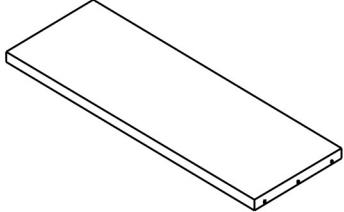
LISTE DES PIÈCES
PARTS LIST

PIÈCE / PART #	IMAGE	DESCRIPTION	QTY / QTÉ
1		<p>COFFEE TABLE TOP SURFACE TABLE À CAFE</p>	1
2		<p>GLASS PANEL PANNEAU EN VERRE</p>	2
3		<p>PLASTIC BAR BARRE DE PLASTIQUE</p>	2

LISTE DES PIÈCES DE MONTAGE
HARDWARE LIST

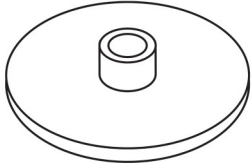
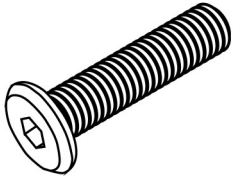
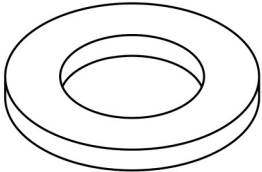
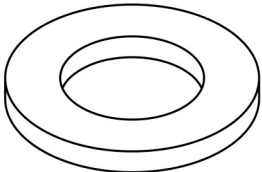
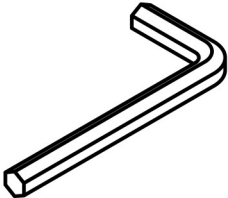
PIÈCE / PART #	IMAGE	DESCRIPTION	QTY / QTÉ
A		SCREW CAP - Ø1/4" X 1 3/8" CAPUCHON DE VIS - Ø1/4" X 1 3/8"	6
B		ASSEMBLING BOLT - Ø1/4" X 1 7/8" BOULON D'ASSEMBLAGE - Ø1/4" X 1 7/8"	6
C		PLASTIC WASHER - Ø3/8" RONDELLE DE PLASTIQUE - Ø3/8"	12
D		METAL WASHER - Ø1/4" RONDELLE DE MÉTAL - Ø1/4"	6
E		HEX KEY CLÉ HEXAGONALE	1

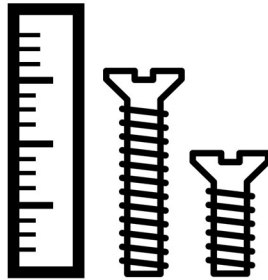

OUTIL DE VÉRIFICATION DE DIMENSIONS DES PIÈCES
HARDWARE DIMENSIONS VERIFICATION TOOL

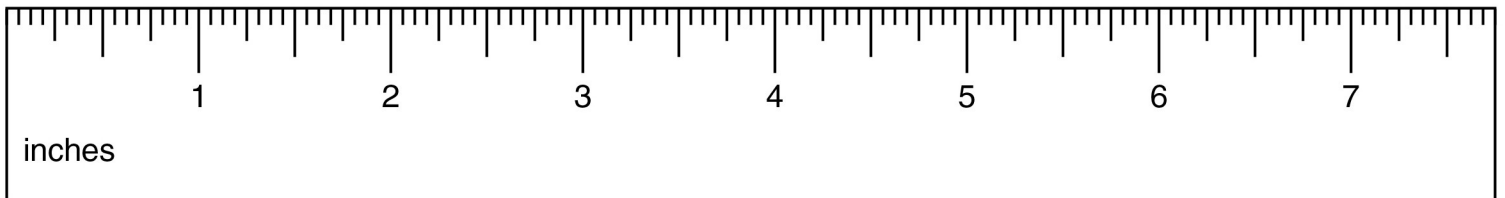

ÉTAPE / STEP 1

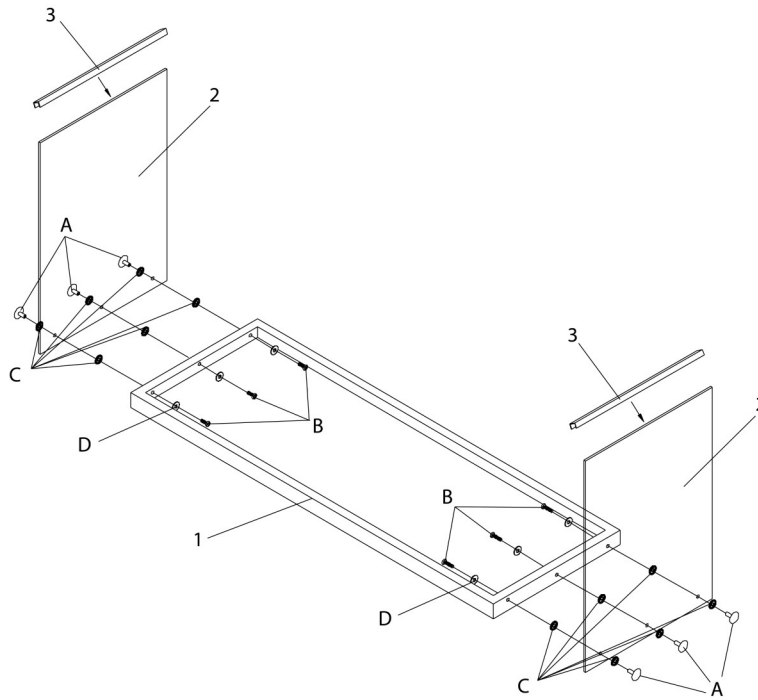

ÉTAPE / STEP 2

